

MA2017-9

**MARINE ACCIDENT
INVESTIGATION REPORT**

September 28, 2017



The objective of the investigation conducted by the Japan Transport Safety Board in accordance with the Act for Establishment of the Japan Transport Safety Board is to determine the causes of an accident and damage incidental to such an accident, thereby preventing future accidents and reducing damage. It is not the purpose of the investigation to apportion blame or liability.

Kazuhiro Nakahashi
Chairman
Japan Transport Safety Board

Note:

This report is a translation of the Japanese original investigation report. The text in Japanese shall prevail in the interpretation of the report.

MARINE ACCIDENT INVESTIGATION REPORT

Vessel type and name: Cargo Ship BBC ASIA

IMO number: 9266310

Gross tonnage: 7,014 tons

Accident type: Death and injury of workers

Date and time: Around 11:31, October 30, 2016 (local time, UTC +9 hours)

Location: Shinko East Quay T Wharf, Kobe Section, Hanshin Port
Around 283° true bearing, 1,480 meters from the Kobe No. 3
Breakwater East Lighthouse located in Kobe City
(approximately 34°41.1'N, 135°12.4'E)

August 31, 2017

Adopted by the Japan Transport Safety Board

Chairman Kazuhiro Nakahashi

Member Kuniaki Shoji

Member Satoshi Kosuda

Member Toshiyuki Ishikawa

Member Mina Nemoto

SYNOPSIS

< Summary of the Accident >

The accident occurred at around 11:31 on October 30, 2016, on the cargo ship BBC ASIA when, during work to load pipes with a crane at Shinko East Quay T Wharf, Kobe Section, Hanshin Port, three workers who were working in a cargo hold were caught between pipes being hoisted by the crane and a side wall. Two of the workers were killed and one was seriously injured.

< Probable Causes >

It is probable that the accident occurred when, as BBC ASIA was being loaded with cargo starboard-side alongside at Shinko East Quay T Wharf, Kobe Section, Hanshin Port, “stainless steel pipes bundled in sets of nine” (the Pipes), which had been hoisted and then stopped by the No. 1 crane, swung to the starboard side, and as a result two stevedores, and one lashing worker, who had been standing by and doing other activities on top of the cargoes that had been stowed on the starboard side, were caught between the Pipes and starboard wall.

It is probable that the Pipes, which had been hoisted and then stopped by the No. 1 crane, swung to the starboard side because—under conditions whereby, at the time of the accident, the underside of the fender on BBC ASIA’s starboard midship hull was caught on the tops of the wharf’s fenders and BBC ASIA’s starboard inclination was arrested because, among other reasons, the height of tide had fallen compared to that at the time of docking and the BBC ASIA’s draft had increased—the underside of the hull’s fender came off the tops of the wharf’s fenders when the Pipes were hoisted by the No. 1 crane and then stopped “at a position at which the Pipes’ starboard side was approximately 3 meters from the starboard wall and bottom was approximately 2.75 meters above the inner bottom plating”(the Stop Position), which caused BBC ASIA’s hull to roll and she inclined to the starboard side.

It is probable that workers were standing by and doing other activities on top of the cargoes that had been stowed on the starboard side at the time of the accident because, in addition to not being prohibited from standing on top of the cargoes for reasons that included over the cargoes not being in the handling area of the Pipes, they could not predict that the Pipes would swing over the cargoes from the Stop Position, as theretofore hoisted cargo had not swing greatly when the crane operation was stopped.

1 PROCESS AND PROGRESS OF THE INVESTIGATION

1.1 Summary of the Accident

The accident occurred at around 11:31 on October 30, 2016, on the cargo ship BBC ASIA when, during work to load pipes with a crane at Shinko East Quay T Wharf, Kobe Section, Hanshin Port, three workers who were working in a cargo hold were caught between pipes being hoisted by the crane and a side wall. Two of the workers were killed and one was seriously injured.

1.2 Outline of the Accident Investigation

1.2.1 Setup of the Investigation

The Japan Transport Safety Board (JTSB) appointed an investigator-in-charge and two other marine accident investigators to investigate this accident on October 31, 2016.

1.2.2 Collection of Evidence

October 31 to November 4, 2016: On-site investigations and interviews

November 7, 11, 15, December 5, 6, 9, 19, 20, 27, 2016, January 17, 19, 20, and 25, 2017:
Collection of questionnaire

November 30, December 1, 2016, February 14, March 21, 27, and April 7, 2017:
Interviews

1.2.3 Test and Research by Other Institutes

With respect to this accident, the JTSB entrusted to the National Maritime Research Institute of the National Institute of Maritime, Port and Aviation Technology the investigations into the circumstances of inclination of the BBC ASIA's hull.

1.2.4 Comments from Parties Relevant to the Cause

Comments on the draft report were invited from the parties relevant to the cause of the accident.

1.2.5 Comments from the Flag State

Comments on the draft report were invited from the flag state of the BBC ASIA.

2 FACTUAL INFORMATION

2.1 Events Leading to the Accident

According to the statements of the master, chief officer, and third officer of the BBC ASIA (hereinafter referred to as “Vessel A”); the foreman*¹ of Kamigumi Co., Ltd., which was contracted to handle stevedoring aboard Vessel A (hereinafter referred to as “Company A”); thirteen stevedores of Kamitsu Koun Co., Ltd., which was a subcontractor of Company A and contracted to handle cargo-handling work (hereinafter referred to as “Company B”); five lashing workers of Toyo CS Corporation, which was a subcontractor of Company A and contracted to handle lashing work (hereinafter referred to as “Company C”); the person in charge at BBC Chartering, which was the operator of Vessel A (hereinafter referred to as “Company D”); and an inspector of the Nippon Kaiji Kentei Kyokai as well as the response to the questionnaire of the master, the events leading to the accident were as follows.

2.1.1 Events in Vessel A’s Navigation

Vessel A departed from Tokyo Section, Keihin Port, with a master and 14 crew members (two nationals of the Russian Federation, eight nationals of the Republic of the Philippines, three nationals of the Ukrainian Republic, and one national of the Republic of Azerbaijan) with a cargo of ten railroad cars (total weight of 340 tons) at around 22:05 on October 28, 2016, and berthed starboard-side alongside at Shinko East Quay T Wharf, Kobe Section, Hanshin Port (hereinafter referred to as “the Wharf”) at around 08:00 on October 30.

2.1.2 Circumstances Prior to Cargo Loading

The foreman, stevedores of Company B, and lashing workers of Company C arrived at the Wharf at around 8:00 on October 30.

The foreman held a meeting with the chief officer and the person in charge of Company D on the stowage positions, lashing methods, and other matters in an office on Vessel A.

At around 08:20, the foreman held a meeting with all workers prior to the start of work, where he explained the cargo to be loaded (specifically, “stainless steel pipes bundled in sets of six or nine in reinforced plastic cases and wrapped with synthetic resin sheet” (hereinafter referred to as “Bundled Pipe”), the scheduled amount of cargo to be handled, stowage positions, lashing methods, and other matters. Then the stevedoring officer of Company B added comments concerning safety, including not entering the area under hoisted cargo (hereinafter referred to as the “Hoisted Cargo”) and its traveling path. (See Photo 2.1-1)



Photo 2.1-1 Bundles of Nine Bundled Pipes

*1 “Foreman” refers to a person who supervises cargo-handling and who holds meetings with the shipping company, its agent, or the shipper on the times and dates of entering/leaving port and the work schedule as well as meetings with the chief officer on the procedure for handling cargo after entering port, safety operations, and other matters.

At around 8:30, Barge SK1001 (hereinafter referred to as “Vessel B”) loaded with the Bundled Pipes that were scheduled to be loaded onto Vessel A berthed port-side alongside on Vessel A’s port side. (See Photo 2.1-2)



Photo 2.1-2 Circumstances of Vessel B Alongside Vessel A (After the Accident)

The foreman decided to first load thirty bundles of Bundled Pipes that were arranged on the Wharf as the cargo to be loaded and notified all workers of his decision.

At around 8:40, Vessel A’s crew made preparations for loading the Bundled Pipes onto the inner bottom plating of the No. 2 cargo hold, which, of the two cargo holds, was on the stern side, after opening the hatch covers for the upper deck of said cargo hold and then opening the hatch covers for the No. 2 deck (pontoon hatch covers).

The chief officer and the person in charge of Company D moved from the upper deck to the forward side of the inner bottom plating of the No. 2 cargo hold.

The foreman and the “operations chief of stevedores who directs cargo-handling” (hereinafter referred to as the “Deckman”) moved to the starboard-side passage of Vessel A’s upper deck, seven stevedores and four lashing workers moved to the inner bottom plating of the No. 2 cargo hold, and a stevedore in charge of crane operation (hereinafter referred to as the “Winchman”) moved to the operator’s seat of the No. 1 crane on the forward side, which was one of two cranes on Vessel A.

The stevedores and lashing workers prepared for cargo-loading, with the stevedores arranging dunnage (square materials used as cushioning) on the inner bottom plating of the No. 2 cargo hold into which the Bundled Pipes would be loaded and the lashing workers standing dunnage on both side walls of the hold.

2.1.3 Circumstances Leading up to the Accident

At around 10:00, Vessel A began loading the 30 bundles of the Bundled Pipe that had been arranged on the Wharf using the No. 1 crane.

The stevedores took charge of stowing the Bundled Pipes that were hoisted by the crane with belt slings and other hoisting equipment by adjusting their positions near the planned stowage position and then removing the belt slings from the Bundled Pipes, and the lashing workers took charge of fixing the Bundled Pipes in place with wire rope and other equipment to prevent their movement during sailing.

The stevedores stowed 22 bundles of nine-piece Bundled Pipes by aligning them transversely to the vessel from the port side to the starboard side on the inner bottom plating of the No. 2 cargo hold (the first layer) and then stowed seven bundles on top of them on the port side (the second layer). They then completed loading the Bundled Pipes

from the Wharf after temporarily placing one bundle of six-piece Bundled Pipes, which differed in height from the nine-piece Bundled Pipes, on the fore side of the No. 2 cargo hold for stowage last.

At around 11:15, Vessel A began loading the 153 bundles of the Bundled Pipe that had been loaded on Vessel B, which was alongside on the port side, using the No. 1 crane.

A “stevedore who directed cargo-handling in the No. 2 cargo hold” (hereinafter referred to as the “Signal Man”) stowed “the first two bundles of nine-piece Bundled Pipes hoisted from Vessel B” (hereinafter referred to as “the Two Bundles”) on the starboard side of the second layer.

The Winchman, operating the No. 1 crane in accordance with signs he received by transceiver from the Deckman, moved “four bundles of nine-piece Bundled Pipes that he hoisted from Vessel B” (hereinafter referred to as “the Pipes”) toward the center of the No. 2 cargo hold. (See Photo 2.1-3)

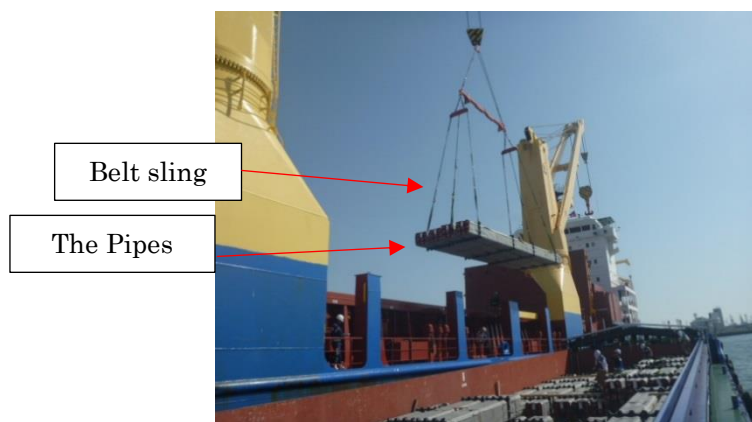

Photo 2.1-3 The Pipes Hoisted from Vessel B
(Courtesy of the Nippon Kaiji Kentei Kyokai)

When he saw the Pipes above the port side of the No. 2 cargo hold, the Signal Man had the Pipes moved toward “the port side of the Two Bundles, which was the planned stowage position” (hereinafter referred to as “the Stowage Position”) by instructing the Winchman by transceiver to rotate the crane jib and lower the wire rope.

Three stevedores (hereinafter referred to as “Stevedore A,” “Stevedore B,” and “Stevedore C”) waited on top of the Two Bundles for the purpose of adjusting the position of the Pipes from the starboard side of the Stowage Position, and three lashing workers (hereinafter referred to as “Lashing Worker A,” “Lashing Worker B,” and “Lashing Worker C”) were engaged in adding dunnage to the starboard wall on top of the Two Bundles.

The Signal Man instructed the Winchman to momentarily stop operating the crane by transceiver so that he could check the positions of the workers and the Stowage Position, having the Pipes stopped “at a position at which the Pipes’ starboard side was approximately three meters from the starboard wall and bottom was approximately two meters above the top of the first layer of Bundled Pipes” (hereinafter referred to as the “Stop Position”) (See Photo 2.1-4)

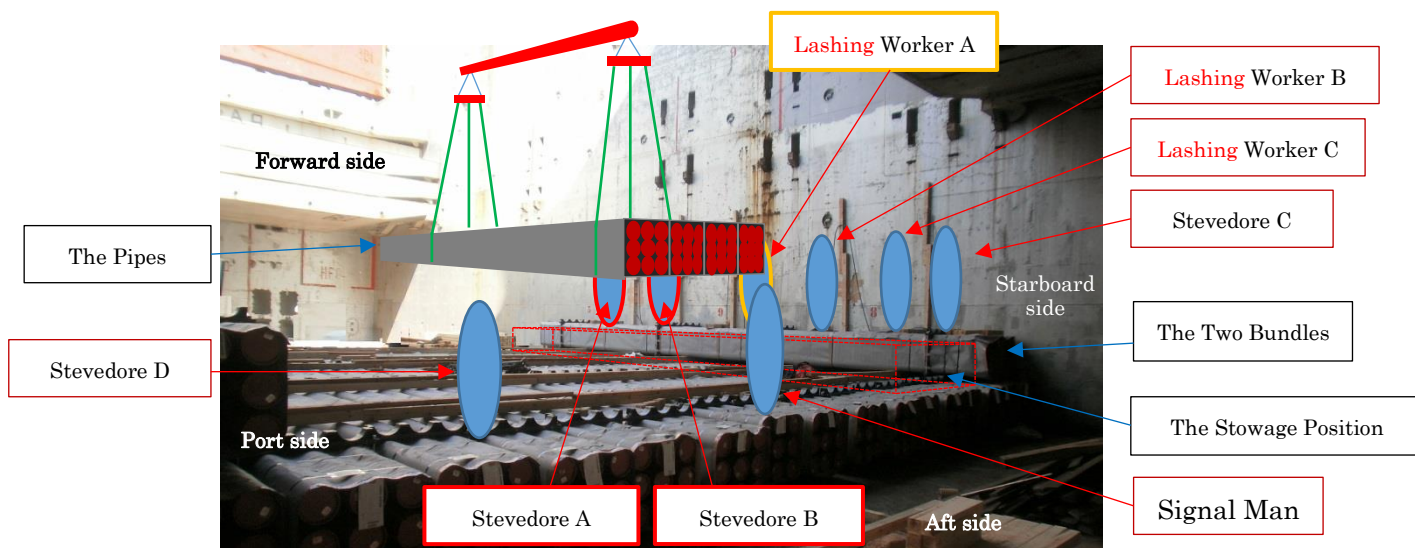

Photo 2.1-4 Arrangement of Workers at the Time of the Accident

The Winchman stopped operating the crane and waited until he received the next instruction from the Signal Man.

The Signal Man visually observed the fore starboard side from the aft side of the Pipes and confirmed that there were no workers in the area under the Pipes. He then was about to instruct the Winchman to lower the crane's wire rope when he saw that stopped the Pipes had begun to move toward the six workers on top of the Two Accident Bundles on the starboard side. He shouted out a warning and took refuge by moving from the top of the first level of Bundled Pipes to the aft port side of the hold's inner bottom plating.

A stevedore who was on the port side of the Pipes (hereinafter referred to as "Stevedore D") attempted to move with the Pipes by walking with his hand on the port aft side of moving the Pipes but could not keep up with the Pipes' speed of movement and his hand was separated from the Pipes.

Stevedore C saw moving the Pipes and told Lashing Worker B and Lashing Worker C, who were working toward the starboard wall on his forward side, that the Pipes were approaching and waited facing the Pipes, but the Pipes approached at an increasing speed, so he squatted down to avoid them and took refuge on the top of the first level of Bundled Pipes.

Lashing Worker B and Lashing Worker C heard the warning from Stevedore C, turned in the port direction, and saw Stevedore C squat and avoid the Pipes, and then instantly squatted down and took refuge on top of the first level of Bundled Pipes.

Lashing Worker A finished working on top of the Two Bundles and turned in the port direction when he saw the Pipes approaching him. He attempted to jump over the Pipes but his waist became caught between the Pipes and the starboard wall.

Lashing Worker A witnessed Stevedore A's head become caught between the Pipes and the starboard wall, and the Signal Man and Stevedore D witnessed Stevedore B become caught between the Pipes and the starboard wall.

The foreman, who was checking the packing of the Bundled Pipes loaded on Vessel B from the port passageway on Vessel A's upper deck, the Deckman, and an inspector who was in the starboard passageway of the upper deck felt Vessel A tilt abnormally to the starboard side. The Deckman and inspector grasped a nearby handrail, thinking that they

would be unable to keep their balance, and then heard the sound of cargo hitting the starboard wall.

The Winchman saw the Pipes hit workers and therefore instantly lifted the Pipes by operating the crane and placed them temporarily on top of Bundled Pipes that had been stowed on the port side. (See Photo 2.1-5)

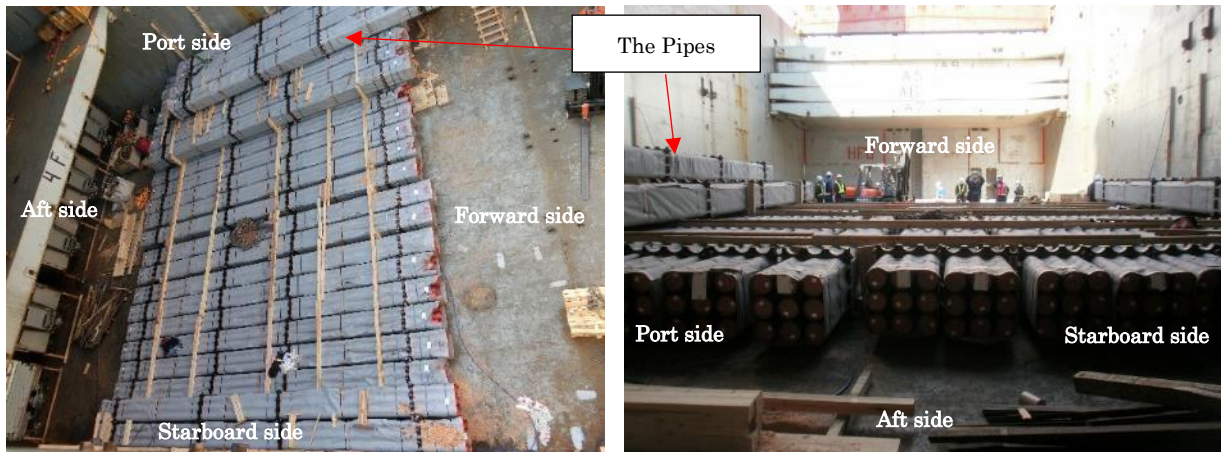

Figure 2.1-5 Circumstances Inside the No. 2 Cargo Hold After the Accident

2.1.4 Circumstances of Rescue

The chief officer, who had been visually checking for damage to the Bundled Pipes on the forward side of the No. 2 cargo hold, notified the master that an accident had occurred and there were injuries by a portable VHF radio telephone and asked the master to prepare pain-relief medicine and the like.

At around 11:33, approximately two minutes after the accident, a stevedore who was standing by on the forward side of the No. 2 cargo hold (hereinafter referred to as “Stevedore E”) called 119. An ambulance arrived at the Wharf at around 11:38.

Stevedore A was confirmed dead at the accident site by a physician.

Stevedore B was given first aid by an emergency response team and physician and then transported to a hospital, but was confirmed dead.

Lashing Worker A was transported to a medical center and admitted.

The date and time of occurrence of the accident was at around 11:31 on October 30, 2016, and the location was the Wharf located in the Kobe Section of Hanshin Port (inside the No. 2 cargo hold of the docked Vessel A).

(See Attached Figure 1 Outline Map of the Accident Location)

2.2 Death and Injury to Persons

(1) Stevedore A

According to the postmortem certificate, the cause of death was crushing of the brain caused by a crush fracture of the skull.

(2) Stevedore B

According to the postmortem certificate, the cause of death was bleeding in the pleuropertitoneal and peritoneal cavity caused by contusions to the liver and both lungs.

(3) Lashing Worker A

According to the medical certificate, Lashing Worker A received a pelvic fracture, a right radial distal fracture, and a right ulnar styloid protuberance fracture. He required hospitalization for approximately three months and subsequent outpatient treatment.

2.3 Damage to Vessel

Vessel A had abrasions on the starboard wall of her No. 2 cargo hold. Eight bundles of Bundled Pipe, including the Pipes, also had abrasions. The location of the abrasions on the starboard wall of the No. 2 cargo hold was approximately 15.82 meters from the forward wall of the cargo hold and approximately 2.75 meters above the inner bottom plating. (See Photo 2.3-1 and Photo 2.3-2)

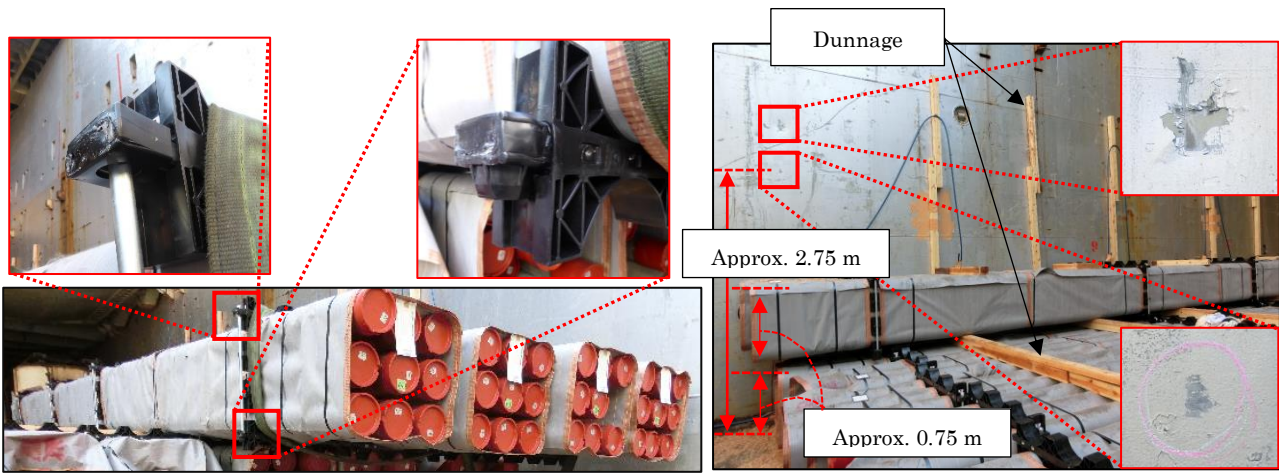

Photo 2.3-1 Pipe Cases

Photo 2.3-2 Abrasions on the Starboard Wall

2.4 Crew Information

2.4.1 Information concerning Vessel A's Crew

(1) Gender, Age, and Certificate of Competence

(i) Master: Male, 48 years old

National of the Russian Federation

Endorsement attesting the recognition of certificate under STCW regulation

I/10: Master (issued by Antigua and Barbuda)

Date of Issue: July 3, 2014

(Valid until April 23, 2019)

(ii) Chief officer: Male, 29 years old, national of the Russian Federation

Endorsement attesting the recognition of certificate under STCW regulation

I/10: Master (issued by Antigua and Barbuda)

Date of Issue: June 10, 2016

(Valid until February 2, 2021)

(2) Sea-going Experience, etc.

According to the statement of the master and chief officer, their sea-going experiences were as follows.

(i) Master

The master served as a master on vessels managed by BRIESE SCHIFFFAHRTS GmbH & Co. KG (hereinafter referred to as "Company E") from

around June 2008. He had approximately three years and six months of experience as a master on sister ships of Vessel A and came aboard Vessel A for the first time on October 26, 2016.

He was in good health at the time of the accident.

(ii) Chief Officer

The chief officer served as a second officer on vessels managed by Company E from around April 2012. He became a chief officer from around November 2013, had served as the chief officer on sister ships of Vessel A on numerous occasions, and came aboard Vessel A for the first time on September 2, 2016.

He was in good health at the time of the accident.

2.4.2 Information concerning the Stevedores, etc.

According to the statements of the foreman, safety officials of Company B and Company C, operations chief of stevedores, Deckman, Signal Man, Winchman, and Lashing Worker A, the main points in the in-company career histories of the stevedores, etc., were as follows.

(1) Foreman Male, aged 33 years

The foreman joined Company A as a foreman in April 2006. He had approximately ten years of experience as a foreman. He had experienced conducting cargo-handling of a nature similar to that taking place at the time of the accident on Vessel A and vessels having a similar structure to Vessel A on numerous occasions.

He was in good health at the time of the accident.

(2) Stevedoring officer Male, aged 58 years

The operations chief of stevedores had been involved in stevedore work since joining Company B in December 1980. He took a skill training course for operations chief of stevedoring work in 1995 and became an operations chief of stevedores in around 2008. He experienced conducting cargo-handling of a nature similar to that taking place at the time of the accident on Vessel A and vessels having a similar structure to Vessel A on numerous occasions.

He was in good health at the time of the accident.

(3) Deckman Male, aged 53 years

The Deckman had been involved in stevedore work since joining Company B in March 1981. He took a skill training course for operations chief of stevedoring work in 1993 and became an operations chief of stevedores in around 2006. He experienced conducting cargo-handling of a nature similar to that taking place at the time of the accident on Vessel A and vessels having a similar structure to Vessel A on numerous occasions.

He was in good health at the time of the accident.

(4) Signal Man Male, aged 52 years

The Signal Man had been involved in stevedore work since joining Company B in July 1988. He took a skill training course for operations chief of stevedoring work in 2005 and became a cargo hold chief in around 2011. He experienced conducting cargo-handling of a nature similar to that taking place at the time of the accident on Vessel A and vessels having a similar structure to Vessel A on numerous occasions.

He was in good health at the time of the accident.

(5) Winchman Male, aged 65 years

The Winchman was qualified as a cargo lifting appliance operator in 1973. He had been involved in stevedore work since joining Company B in around February 1982. He had approximately twenty years of experience as a crane operator. He had experienced conducting cargo-handling of a nature similar to that taking place at the time of the accident on Vessel A and vessels having a similar structure to Vessel A on numerous occasions.

He was in good health at the time of the accident.

(6) Stevedore A Male, aged 57 years

Stevedore A took a skill training course for slinging operation in 1981 and became involved in stevedore work. He joined Company B in around February 2000. He experienced conducting cargo-handling of a nature similar to that taking place at the time of the accident on Vessel A and vessels having a similar structure to Vessel A on numerous occasions.

He was wearing a helmet and safety shoes and appeared to be in good health at the time of the accident.

(7) Stevedore B Male, aged 19 years

Stevedore B had been involved in stevedore work since joining Company B in April 2015. He took a skill training course for slinging operation in June 2016 and experienced conducting cargo-handling of a nature similar to that taking place at the time of the accident on numerous occasions.

He was wearing a helmet and safety shoes and appeared to be in good health at the time of the accident.

(8) Lashing Worker A Male, aged 32 years

Lashing Worker A had been involved in cargo-lashing work since joining Company C in March 2005. He had approximately eleven years of experience in cargo-lashing. He had experienced conducting cargo-lashing of a nature similar to that taking place at the time of the accident on Vessel A and vessels having a similar structure to Vessel A on numerous occasions.

He was wearing a helmet and safety shoes and was in good health at the time of the accident.

2.5 Vessel Information

2.5.1 Particulars of Vessel A

IMO number:	9266310
Port of registry:	St. John's (Antigua and Barbuda)
Owner:	BRIESE SCHIFFAHRTS GmbH & Co. KG MS "Embse" (Federal Republic of Germany)
Management company:	Company E (Federal Republic of Germany)
Operator:	Company D (Federal Republic of Germany)
Class:	Det Norske Veritas Germanischer Lloyd (Kingdom of Norway)
Gross tonnage:	7,014 tons
L×B×D:	119.78 m x 20.20 m x 9.80 m
Hull material:	Steel
Engine:	Diesel engine x 1
Output:	6,300 kW

Propulsion: Controllable pitch propeller x 1
 Date of keel laid: June 2002
 (See Photo 2.5-1)



Photo 2.5-1 Vessel A

2.5.2 Hull Structure of Vessel A

According to the general arrangement plan, the hull structure of Vessel A was as follows.

- (1) Vessel A was a cargo ship with a docking bridge. She had two cargo holds ordered from the bow as the No. 1 cargo hold and No. 2 cargo hold. Each cargo hold could be divided into an upper and lower section by arranging pontoon hatch covers on an opening on the No. 2 deck. Two cranes were installed on the port side, ordered from the bow as the No. 1 crane and No. 2 crane.
- (2) Vessel A had a semicircular steel fender with a diameter of 0.3 meters welded along a distance of approximately 95.4 meters from the stern end on both sides of the hull (hereinafter referred to as the “Hull Fender”). The Hull Fender was welded as top and bottom sides at the hull’s center. The center of the bottom side was 7.25 meters from the vessel’s bottom. (See Figure 2.5)

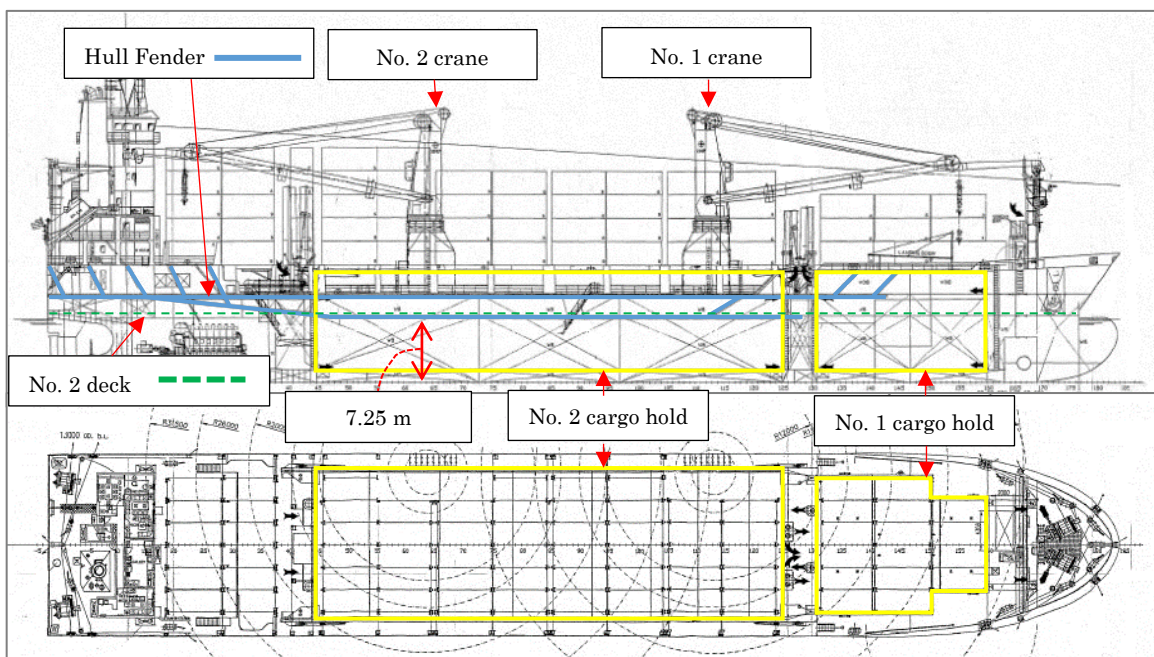

Figure 2.5 General Arrangement Plan

2.5.3 Lifting Appliances on Vessel A

According to the crane instruction manual, the cranes installed on Vessel A were swiveling jib-type hydraulic cranes. Each had a load limit, limit radius, and swivel angle of 25 to 250 tons, 2.5 to 26 meters, and 360°, respectively.

According to the statements of the chief officer, Winchman, and port state control officer who conducted an onsite inspection of Vessel A after the accident, there was no malfunction or failure in the No. 1 crane at the time of the accident.

2.5.4 Vessel A's Load Conditions, etc.

According to Vessel A's cargo record and stability calculation report, the loading condition, draft, metacentric height*² (G_oM), and so on at the time of the accident were as follows.

Loaded cargo	Weight (t)	Draft	
Railroad cars	340.0	Bow	5.24m
Bundled Pipes	140.0	Midship	5.61m
Ballast water	2,499.6	Stern	5.99m
Fresh water	81.0	Displacement	8,703t
Fuel oil	194.1	GoM	1.41m
Lubricating oil	32.5		

It should be noted that Vessel A's draft at the time that it docked at the Wharf was 5.05 meters at the bow, 5.53 at the midship, and 6.03 meters at the stern.

2.5.5 Information concerning Vessel A's Cargo

(1) The Bundled Pipes

A single bundle of nine-piece Bundled Pipes had a length of between 10.00 to 12.00 meters, a height and width of approximately 0.62 meters, and a weight of between 4.40 and 4.50 tons.

(2) The Pipes

The Pipes were comprised of four bundles of nine-piece Bundled Pipes and had a length of approximately 11.50 meters, a height of approximately 0.62 meters, a width of approximately 2.80 meters, and a weight of approximately 17.93 tons.

2.5.6 Information concerning the Wharf

According to detailed wharf structure drawings of the Wharf, the situation was as follows.

*² "Metacentric height" refers to the distance (GM) between the hull center of gravity G and the metacenter M, which is the intersection of the line of action of the buoyant force that passes through the center of buoyancy when the vessel is listing and the hull center line. In this report, it refers to metacentric height that takes free water effect into account (GoM).

(1) Fenders on the Wharf

Eleven V-shaped rubber fenders measuring 0.60 meters in height and 2.30 meters in length were installed horizontally at intervals of twenty meters on the Wharf's surface.

(2) Bumpers on the Wharf

The bumpers had a height of 0.20 meters.

(3) Height of the Wharf

The crown height^{*3} of the Wharf was 4.00 meters. The height of the reference level of tide observations from the standard sea level is 0.12 meters.

2.5.7 Circumstances of Catching of Wharf Fenders and Hull Fender

At around 13:00 on November 1, with a height of tide (end of outgoing tide) and draft equivalent to those at the time of the accident, the underside of Vessel A's starboard-side Hull Fender contacted with and became caught on the tops of three fenders on the Wharf at approximately 30 meters, 49.6 meters, and 69.4 meters from Vessel A's stern end toward the bow. When the underside of the Hull Fender came off the tops of the wharf fenders, Vessel A's hull inclined toward the starboard side and rolled several times. Additionally, rust from the underside of Vessel A's Hull Fender was on the tops of the fenders on the Wharf. (See Photo 2.5-2)

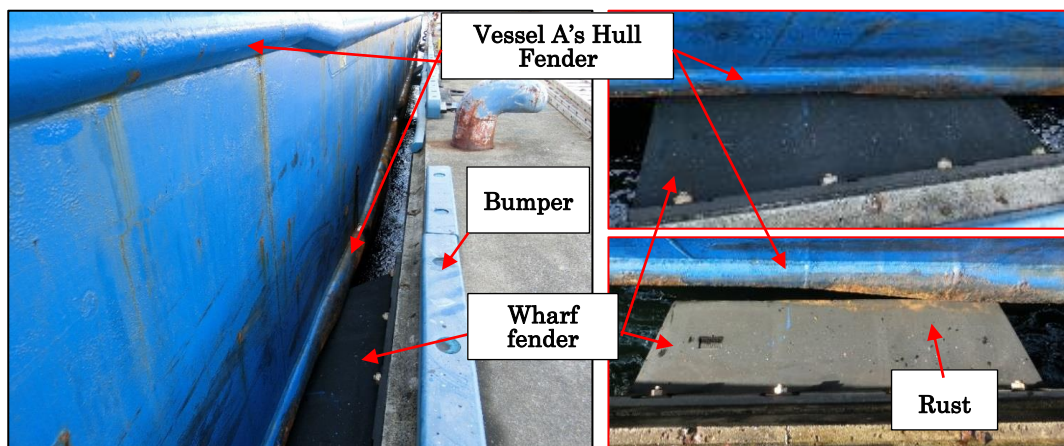

Photo 2.5-2 Fenders on the Wharf

2.6 Weather and Sea Conditions

2.6.1 Weather and Wave Observations

(1) Weather Observation

Meteorological observations at the Kobe Local Meteorological Office, which is located approximately 1.4 km north-northeast from the accident site, at the time of the accident were as follows.

- | | | |
|-------|---------------------|---|
| 11:20 | Wind direction: ESE | Wind speed: 2.2 m/s (peak gusts of 3.0 m/s) |
| 11:30 | Wind direction: ESE | Wind speed: 2.0 m/s (peak gusts of 2.9 m/s) |
| 11:40 | Wind direction: ESE | Wind speed: 1.7 m/s (peak gusts of 3.0 m/s) |

^{*3} "Crown height" refers to height from the standard sea level to the top of a wharf, breakwater, seawall, etc.

(2) Wave Observation

Wave observations at the “Kobe” NOWPHAS^{*4} observation point, which is located approximately 4.1 nautical miles (M) east-southeast from the accident site, at the time of the accident were as follows.

11:20 Wave height: 0.22 meters Period: 3.4 seconds

11:40 Wave height: 0.23 meters Period: 3.3 seconds

(3) Tide Data

According to the tide table published by JCG, the tide in the Kobe Section of Hanshin Port was as follows.

8:00 Beginning of outgoing tide Height of tide: 137 cm

11:31 End of outgoing tide Height of tide: 90 cm

2.6.2 Observations by Crew Members

(1) According to Vessel A’s logbook, the situation was as follows.

12:00 Weather: Fine Wind force: 1 Air temperature: 17.0 °C

Wave height: 0.00 to 0.10 meters

(2) According to the statement of Stevedore E, no wind, waves, or swells were observed.

2.7 Information concerning the Rolling of Vessel A’s Hull

(1) According to the statement of the Signal Man, Vessel A inclined slightly to the port side after the second bundle was loaded.

(2) According to the reply to the questionnaire of the master, at the time of the accident, the third officer and an able seaman were keeping the mooring lines that were moored to bitts on the wharf evenly taut by appropriately operating the mooring machines whenever the lines slackened as a result of the outgoing tide.

(3) According to the statement of the chief officer, at the time of the accident, Vessel A was not taking on or releasing ballast water, refueling, or replenishing her water supply, and the hull’s rolling and inclination were the same as normally experienced during cargo-handling.

(4) According to the statement of the third officer, at the time of the accident, he felt an inclination to the starboard side of more than 3°, which is unlike the inclination normally experienced during cargo-handling, as he was preparing documents on the port side of the bridge. He then heard the sound of a metallic object hitting a wall. About one minute later, he heard the voice of the Chief Officer requesting stretchers by portable VHF radio telephone.

(5) According to the statement of a stevedore who was clearing away cargo-handling materials on the Wharf (hereinafter referred to as “Stevedore F”), at the time of the accident, Vessel A inclined to starboard several seconds after the jib of the No. 1 crane stopped moving, and for around eight seconds Vessel A inclined so that the lower

^{*4} “NOWPHAS” (Nationwide Ocean Wave information network for Ports and HARbourS (Ports and Harbours Bureau, MLIT)) is a wave information network for Japan’s coastlines that was built and is operated through a collaborative effort by the Ports and Harbours Bureau, MLIT; Regional Development Bureaus, MLIT; Hokkaido Bureau, MLIT; Okinawa General Office, Cabinet Office; National Institute for Land, Infrastructure and Management (NILIM); and Port and Airport Research Institute (PARI).

horizontal bar of the handrail installed on the starboard side of Vessel A's upper deck was at the same height as the bumpers on the wharf.

- (6) According to the statements of four stevedores who were working on Vessel B, at the time of the accident, Vessel A inclined greatly to starboard and then rolled several times.
- (7) According to the statements of the foreman and one of the stevedores who was working on Vessel B, at the time of the accident, there were no navigating vessels in the vicinity of Vessel A and no ship-generated waves, etc., were present.
- (8) According to the statements of the safety officers of Company A, Company B, and Company C as well as six stevedores, when two cranes are handling cargo from more than one hold, cargo being hoisted by one crane may swing somewhat due to the effect of rolling caused by movement of the other crane's jib. However, at the time of the accident, the jibs of the No 1 and No. 2 cranes were stopped and there was no significant swinging of the Hoisted Cargo.

2.8 Information on Safety Management

2.8.1 Health and Safety Management Regulations

Company A and Company B established health and safety management regulations that were based on the Industrial Safety and Health Act as well as regulations and guidelines that are based on the act. Said regulations mention compliance with matters to be observed of the Regulations for the Prevention of Occupational Accidents in the Port Transport Business (hereinafter referred to as the "Accident Prevention Regulations") (see 2.8.3) and, for the safe execution of work, prohibition of entry into the traveling path of hoisted cargo and requirement to stand away from such paths.

2.8.2 Education on Safe Operations, etc.

- (1) According to the statements and replies to the questionnaire from the safety officers of Company A, Company B, and Company C, Company A, Company B, and Company C made operation standards sheets that established work procedures, division of work duties, matters for compliance, etc., for each operation in stevedoring well known among workers, and routinely educated workers not to enter areas under hoisted cargo and the traveling path of hoisted cargo.
- (2) According to the statements of the safety officers of Company A, Company B, and Company C as well as the foreman, six stevedores, and three lashing workers, the normal cargo-handling procedure is to move cargo in the direction of the stowage location after the bottom of the hoisted cargo is lowered to a height of 20 to 30 centimeters above the landing surface. Because the same procedure was followed at the time of the accident, Company A, Company B, and Company C did not prohibit workers from standing on top of the Two Bundles because, even if the Pipes swung, they would not hit the workers on top of the Two Bundles, which had a height of approximately 75 cm above the landing surface, and because the Two Bundles were not in the traveling path of the Pipes.

2.8.3 Accident Prevention Regulations

Company A, Company B, and Company C are members of the Japan Port Transport Industry Safety & Health Association, whose members are port cargo transport businesses.

The association has established in its Accident Prevention Regulations the following stipulations intended to prevent industrial accidents in the port cargo transport business. (Chapter 2 in the Accident Prevention Regulations stipulates as follows.)

Chapter 2. Prevention of accidents during stevedore work

Section 3. Stevedore work

(Work plan)

Article 29. Members shall develop a work plan to conduct safe work before starting stevedore work according to the structure, workplace, and equipment of the vessel in which the said work is conducted as well as the type, shape, and packing of the cargo to be handled; and conduct the work according to the said work plan.

(Operations chief of stevedores)

Article 30. Members shall appoint an operations chief of stevedores when conducting stevedore work and have the person implement the following items.

2. Notify relevant stevedores the necessary items to conduct safe work, such as the work procedure, work signaling method, evacuation location and evacuation method in case of emergency, mutual communication method, etc. and directly lead the work.

3. and 4. (omitted)

Section 4. Operation of cargo lifting appliance

(Inhibition of passing and entering)

Article 57. Members shall inhibit stevedores from passing or entering, while operating a lifting appliance, on the travelling path of the lifted cargo or under the lifted cargo.

(Signals for operation of lifting appliance)

Article 61. Members shall stipulate signals for operation of lifting appliance, appoint signal person for each one of the lifting appliances, and have the person make signals for operation.

2. Members shall have the operations chief of stevedores to make the signals mentioned in the above clause (excluding signals for relaying operations). However, if it is necessary due to work circumstance, members may appoint a person who has completed the chief of stevedores course and have the person to make signals for operation of the lifting appliance. (The rest is omitted)

3. Members shall have the signal persons for operation of lifting appliance to make signals according to the following guidelines based on the signaling method stipulated in clause 1. Members shall also have relevant stevedores conduct work according to the signals.

i. Clearly make signals from locations where the situations of the lifting appliance operator, slinging stevedores, and the lifted cargo are visible at all times.

ii. to iv. (omitted)

v. Confirm that no stevedore or anyone else is under the lifted cargo or on the travelling path of the lifted cargo and continue to monitor during the operation work.

2.9 Analytical Investigation into the Causes of the Accident

The following provides an outline of the results of an analytical investigation of the circumstances of the hull inclination in the accident involving Vessel A that was conducted by the National Maritime Research Institute of the National Institute of Maritime, Port and Aviation Technology.

2.9.1 Stability, etc., at the Time of the Accident

According to Vessel A's stability calculation report, the draft, GoM, and other circumstances at the time of the accident were as provided in Table. 2.9. According to Vessel A's crane instruction manual, the jib of the No. 1 crane had a length of 37.185 meters and a weight of 56.20 tons. The weights of the small hook and large hook of the same jib were 1.03 tons and 6.30 tons, respectively. Additionally, according to the reply to the questionnaire of Company B, at the time of the accident, cargo-loading was taking place using the small hook at the end of the jib, and the weight, which included the weight of the Pipes and hoisting equipment, was approximately 19.01 tons.

Table 2.9 Draft, GoM, etc., at the Time of the Accident

Fore draft	Midship draft	Stern draft	Displacement	GoM	Height of center of gravity* ⁵ (KGo)
5.24 m	5.61 m	5.99 m	8703.20 t	1.41 m	7.10 m

According to the statements of workers, the Stop Position was at a height of approximately two meters above the first level of Bundled Pipes (height from the inner bottom plating of approximately 0.75 meters). Thus, the height from the inner bottom plating is assumed to have been 2.75 meters and the distance from the forward wall is assumed to be 14.9 meters, which was estimated from the position of the abrasions on the starboard wall.

2.9.2 Estimation of the Hull Inclination Angle, etc., at the Time of the Accident

The hull inclination angle and other circumstances were estimated as follows based on identification of the jib's swivel angle and angle of elevation when the Pipes were hoisted to the Stop Position by the No. 1 crane and correction of stability in accordance with the jib's angle of elevation.

- (1) Case in which the underside of Vessel A's Hull Fender does not catch on the tops of the fenders on the Wharf

The hull inclination angle θ_1 is approximately 2.08° to the starboard side.

- (2) Case in which the underside of Vessel A's starboard Hull Fender does catch on the tops of the fenders on the Wharf

- 1) Positional relationship between the hull and the wharf

The positional relationship between the hull and the wharf is as shown in Figure 2.9-1. The hull inclination angle θ_2 is approximately 1.79° to the port side.

*⁵ "Height of the center of gravity" refers to the height from the top surface of the bottom plating to the center of gravity of the hull.

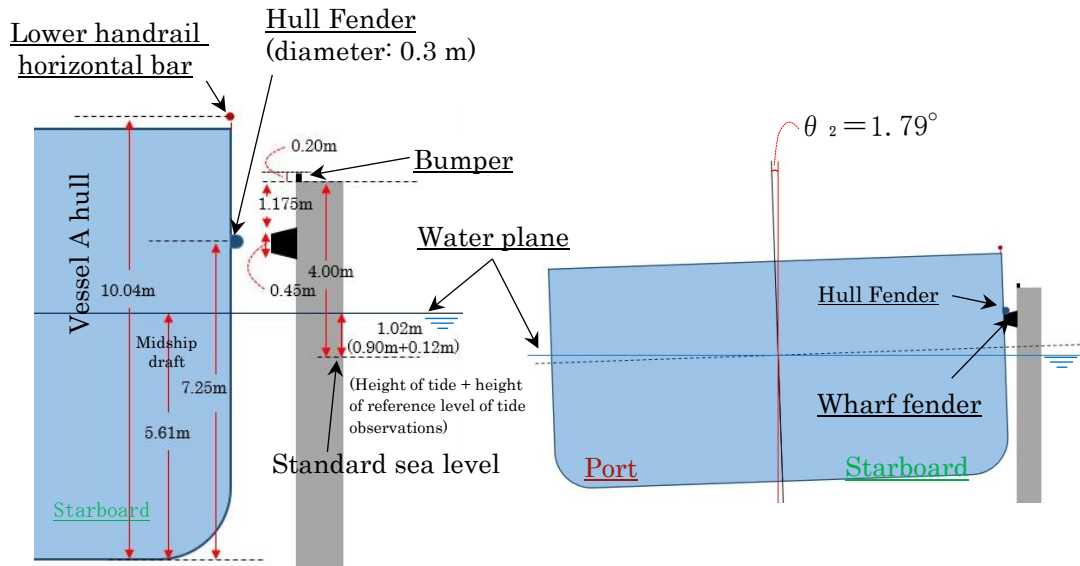

Figure 2.9-1 Positional Relationship between the Hull and Wharf

- 2) Inclination moment acting on the hull when the Pipes were hoisted to the Stop Position

Under the conditions described in 1) above, even when the Pipes are hoisted to the Stop Position by the No. 1 Crane, the inclination toward the starboard side is arrested by the catching of the underside of Vessel A's Hull Fender with the tops of the wharf fenders. Thus, the hull inclination angle is at approximately 1.79° (θ_2) to the port side, and an inclination moment corresponding to approximately 2.44° (θ_3) to the starboard side that arises from this inclination to the port side acts on Vessel A.

- 3) Hull inclination angle generated when the Hull Fender's underside comes off the wharf fenders

Under the conditions described in 2) above, when the underside of the Hull Fender comes off the tops of the wharf fenders, Vessel A rolls at inclinations ranging from θ_2 to the maximum inclination angle to the starboard side (θ_4), with inclination angle θ_3 being at the center. At this time, inclination angle θ_4 , which was calculated based on the assumption that the workload formed by the stability of θ_2 to θ_3 and θ_3 to θ_4 , respectively, will equalize, becomes approximately 6.93° to the starboard side.

- (3) Hull inclination angle according to the statements

According to the statement of Stevedore F, the hull inclination angle at the time of the accident was in a state in which the lower horizontal bar of the handrail installed on Vessel A's starboard upper deck was roughly at the same height as the Wharf's bumper. This would make hull inclination angle θ_5 7° to the starboard side, which roughly matches inclination angle θ_4 . (See Figure 2.9-2)

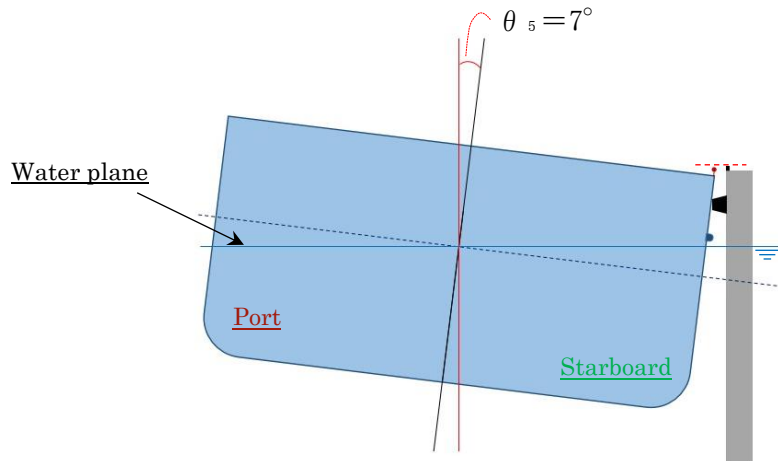

Figure 2.9-2 Circumstances of the Hull Inclination Angle at the Time of the Accident

- (4) Hull inclination angle when the Pipes came into contact with the starboard wall of the No. 2 cargo hold

In the case of (2) 2) above, the Pipes were stopped at a position approximately three meters from the No. 2 cargo hold's starboard wall. Thus, the Pipes were in a state in which they would contact with the starboard wall on a pendular traveling path centered on the crane jib's end in the event of an approximately 1.81° inclination of the hull to the starboard side. (See Figure 2.9-3)

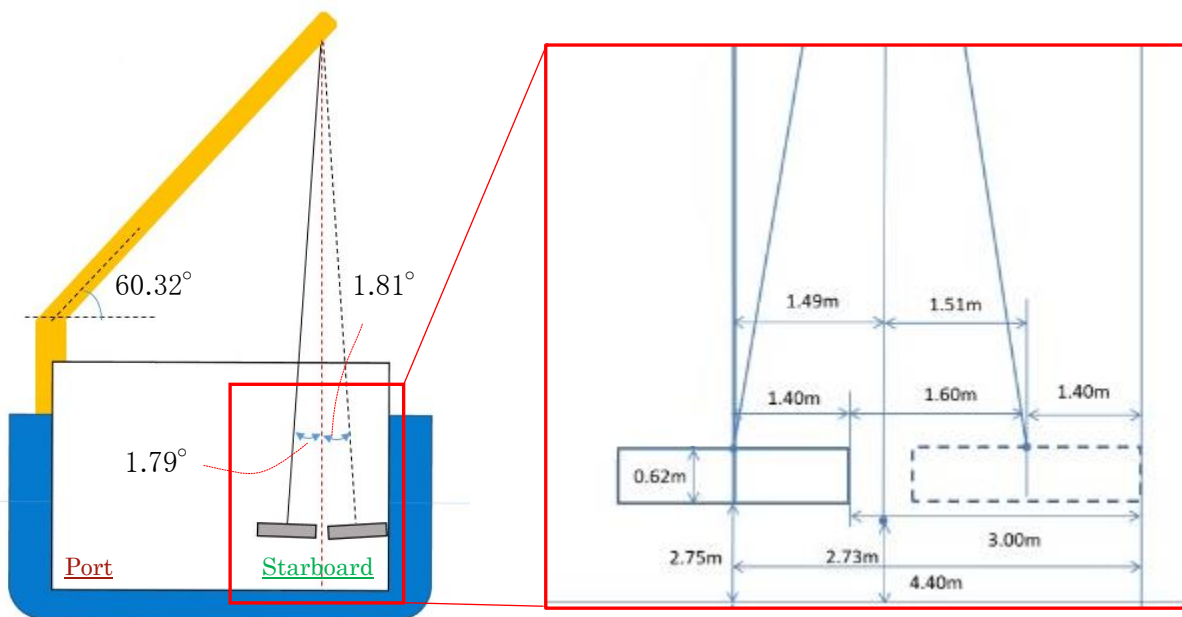

Figure 2.9-3 Positional relationship between the Pipes and the Starboard Wall

2.9.3 Summary of the Circumstances of the Hull Inclination at the Time of the Accident

It is probable that the circumstances of the hull inclination, etc., at the time of the accident involving Vessel A can be explained by a situation in which, under conditions whereby Vessel A's starboard inclination was arrested because the underside of her starboard Hull Fender was caught on the tops of the wharf fenders, the Hull Fender's underside came off of the tops of the wharf fenders when the Pipes were hoisted by the No.

1 crane and then stopped at the Stop Position, and that the Pipes, which had been hoisted to the Stop Position, then collided with the No. 2 cargo hold's starboard wall when the hull inclined by at least 1.81° to the starboard side.

3 ANALYSIS

3.1 Situation of the Accident

3.1.1 Course of the Events

According to 2.1, 2.3, and 2.7, it is probable that the following events occurred.

- (1) At around 8:00 on October 30, 2016, Vessel A docked starboard-side alongside at the Wharf in the Kobe Section of Hanshin Port.
- (2) At around 10:00, Vessel A began loading Bundled Pipes that had been arranged on the Wharf onto the inner bottom plating of her No. 2 cargo hold using her No. 1 crane. Stevedores stowed 22 bundles of nine-piece Bundled Pipes by aligning them transversely to the vessel from the port side to the starboard side on the inner bottom plating of the No. 2 cargo hold (the first layer), and then stowed a second layer of seven bundles on the port side, temporarily placed one bundle of six-piece Bundled Pipes on the fore side of the No. 2 cargo hold, and completed loading of the Bundled Pipes from the Wharf.
- (3) At around 11:15, Vessel A began loading the Bundled Pipe that had been loaded on Vessel B, which was alongside on the port side, using the No. 1 crane and stowed the Two Bundles on the second layer's starboard side.
- (4) The Deckman moved the Pipes by instructing the Winchman by transceiver to hoist the Pipes from Vessel B and move them to the center of the No. 2 cargo hold.
- (5) The Signal Man moved the Pipes by instructing the Winchman by transceiver to rotate the crane's jib toward the Stowage Position and lower the wire rope. Then the Signal Man instructed the Winchman to temporarily stop operating the crane so he could check the positions of workers and other circumstances, and the Winchman stopped the Pipes at the Stop Position by stopping crane operation.
- (6) After the jib of the No. 1 crane was stopped, Vessel A inclined to starboard and inclined to the point that the lower horizontal bar of the handrail installed on the starboard side of Vessel A's upper deck was at about the same height as the bumpers on the wharf.
- (7) The Pipes began moving in the starboard direction.
- (8) Stevedore A, Stevedore B, and Lashing Worker A, who were standing by and doing other activities on top of the Two Bundles, were caught between the Pipes and the starboard wall.

3.1.2 Date, Time and Location of the Accident Occurrence

According to 2.1.1, 2.1.3, and 2.1.4, it is probable that the date and time of occurrence of the accident was at around 11:31 on October 30, 2016, and the location was at the Wharf in the Kobe Section of Hanshin Port (inside the No. 2 cargo hold of the docked Vessel A).

3.1.3 Death and Injury to Persons

According to 2.2, Stevedore A died by crushing of the brain caused by a crush factor of the skull, Stevedore B died from bleeding in the pleuroperitoneal and peritoneal cavity caused by contusions to the liver and both lungs, and Lashing Worker A received a pelvic fracture, a right radial distal fracture, and a right ulnar styloid protuberance fracture.

3.1.4 Damage to Vessel

According to 2.3, it is highly probable that the accident caused abrasions on the starboard wall of Vessel A's No. 2 cargo hold and abrasions on eight bundles of Bundled Pipe, including the Pipes.

3.2 Causal Factors of the Accident

3.2.1 Situation of Crew Members

According to 2.4, the situations of the crew members were as follows:

(1) Master and Chief Officer

It is probable that Master and Chief Officer possessed a legally valid certificate of competence and was in good health at the time of the accident.

(2) Stevedores

It is probable that the foreman, Deckman, Signal Man, Winchman, and Lashing Worker A had experienced conducting cargo-handling or cargo-lashing of a nature similar to that taking place at the time of the accident on Vessel A and vessels having a similar structure to Vessel A on numerous occasions, and that they were in good health at the time of the accident.

It is considered somewhat likely that Stevedore A had experienced conducting cargo-handling of a nature similar to that taking place at the time of the accident on Vessel A and vessels having a similar structure to Vessel A on numerous occasions, and that he was in good health at the time of the accident.

It is considered somewhat likely that Stevedore B had experienced conducting cargo-handling of a nature similar to that taking place at the time of the accident on numerous occasions, and that he was in good health at the time of the accident.

3.2.2 Situations of the Vessels

According to 2.5.3, it is probable that there was no malfunction or failure with the No. 1 crane.

3.2.3 Weather and Sea Conditions

According to 2.6, it is probable that at the time of the accident the weather was fine, the wind was blowing from the east-southeast with an average wind speed of 2.0 m/s and peak gusts of 2.9 m/s, the waves were coming from the west-southwest and south with a height of approximately 0.2 meters, the tide at the end of an outgoing tide with a height of 90 cm, and the tide level difference at around 8:00 when Vessel A docked was 47 cm.

3.2.4 Analysis concerning the Catching of Vessel A's Hull Fender on the Fenders on the Wharf

According to 2.5, 2.6.1, 2.7, 2.9, and 3.2.3, it is probable that the situation was as follows.

(1) At around 8:00, when Vessel A docked, the height of tide was 137 cm and the vertical distance from the underside of the Hull Fender on her hull's starboard midship and tops of the fenders on the Wharf was approximately 23.5 cm. Thus, the underside of the Hull Fender was not in contact with the tops of the wharf fenders.

(2) In the event that the total of the amount of decrease in the height of tide at the time of docking and amount of increase in draft coming from cargo-loading was greater than approximately 23.5 cm and Vessel A's plating shell and the fenders on the Wharf were

in contact, the underside of the Hull Fender on her hull's starboard midship and tops of the fenders on the Wharf would catch.

- (3) Given that it is probable that, at the time of the accident, height of tide was 90 cm, the amount of decrease in the height of tide from the time of docking was 47 cm, the amount of increase in draft at the hull's midship was approximately 8 cm, and the total of those two amounts was approximately 55 cm, and that crew members were acting as appropriate to keep the mooring lines evenly taut and therefore the hull's plating shell and the fenders on the Wharf were in contact, the underside of the Hull Fender on the starboard midship of the hull caught on the tops of the fenders on the Wharf. (See Figure 3.2)

3.2.5 Analysis of the Hull's Inclination

According to 2.5, 2.7, 2.9, 3.1.1, 3.2.3, and 3.2.4, it is probable that the situation was as follows.

- (1) Assuming that the underside of the starboard Hull Fender did not catch on the tops of the fenders on the Wharf at the GoM at the time of the accident, if the jib of the No. 1 crane hoisted the Pipes after being rotated to the position at which it was stopped at the time of the accident, Vessel A would incline approximately 2.08° to the starboard side.
- (2) At the time of the accident, Vessel A's hull included approximately 7° to the starboard side and then rolled several times.
- (3) At the time of the accident, Vessel A was neither engaging in crane jib operation that would cause a hull inclination nor taking on or releasing ballast water, etc. Additionally, no strong winds, ocean waves, or ship-generated waves were present.
- (4) Assuming that, at the time of the accident, Vessel A's starboard inclination was arrested because the underside of Vessel A's starboard Hull Fender and the tops of the fenders on the Wharf caught, if the underside of the Hull Fender came off the tops of the wharf fenders when the Pipes were hoisted by the No. 1 crane and stopped at the Stop Position, a hull roll would occur and Vessel A would incline approximately 6.93° to the starboard side. This situation roughly matches the inclination mentioned in (2) above.
- (5) From (1) to (4) above, under conditions whereby, at the time of the accident, the underside of Vessel A's starboard Hull Fender was caught on the tops of the wharf's fenders and Vessel A's starboard inclination was arrested, the underside of the Hull Fender came off the tops of the wharf fenders when the Pipes were hoisted by the No. 1 crane and then stopped at the Stop Position, which caused her hull to roll and she inclined approximately 7° to the starboard side.

3.2.6 Analysis of the Swing of the Pipes

According to 2.1, 2.3, 2.9 and 3.2.5, it is probable that the situation was as follows.

- (1) Prior to the accident, Vessel A stopped the Pipes as the Stop Position by stopping operation of the No. 1 crane.
- (2) Under the circumstances described in (1) above, if Vessel A's hull inclined approximately 1.81° or more to the starboard side, the Pipes would collide with the starboard wall of the No. 2 cargo hold.

- (3) Because, at the time of the accident, Vessel A's hull rolled and she inclined approximately 7° to the starboard side, the stopped Pipes swung in the starboard direction on a pendular traveling path centered on the crane jib's end and collided with the starboard wall of the No. 2 cargo hold. (See Figure 3.2)

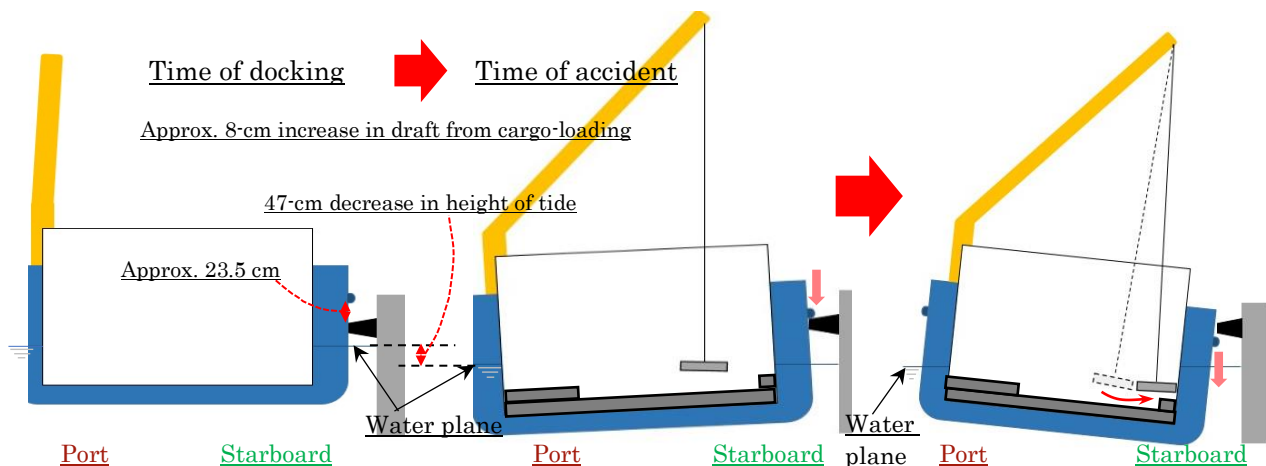

Figure 3-2 Circumstances of the Accident

3.2.7 Analysis of the Safety Management

According to 2.7, 2.8, 3.2.5, and 3.2.6, the safety management situation was as follows:

- (1) Company A, Company B, and Company C complied with Health and Safety Management Regulations and the Accident Prevention Regulations, made operation standards sheets well known among workers, and educated workers not to enter areas under hoisted cargo and the traveling path of hoisted cargo.
- (2) Company A, Company B, and Company C did not prevent workers from standing on top of the Two Bundles because, under normal cargo-loading procedure, the Pipes would not hit workers on top of the Two Bundles even if they swung and because the Two Bundles were not in the traveling path of the Pipes.
- (3) Workers were standing by and doing other activities on top of the Two Bundles at the time of the accident because, in addition to (2) above, they could not predict that the Pipes would swing over the Two Bundles from the Stop Position, as theretofore Hoisted Cargo had not swing greatly when the crane operation was stopped.

3.2.8 Analysis of the Accident Occurrence

According to 3.1.1 and 3.2.4 to 3.2.7, the analysis of the accident was as follows:

- (1) While Vessel A was being loaded with cargo starboard-side alongside at the Wharf, the Signal Man hoisted the Pipes with the No. 1 crane and then stopped the pipes at the Stop Position by issuing instructions to the Winchman.
- (2) Under conditions whereby, at the time of the accident, the underside of the Hull Fender on Vessel A's starboard midship hull was caught on the tops of the Wharf's fenders and Vessel A's starboard inclination was arrested because, among other reasons, the height of tide had fallen compared to that at the time of docking and the vessel's draft had increased, the underside of the Hull Fender came off the tops of the wharf fenders when the Pipes were hoisted by the No. 1 crane and then stopped at the

Stop Position, which caused her hull to roll and she inclined approximately 7° to the starboard side.

- (3) The stopped Pipes swung to the starboard side from the inclination of Vessel A's hull to the starboard side, and as a result Stevedore A, Stevedore B, and Lashing Worker A, who had been standing by and doing other activities on top of the Two Bundles, were caught between the Pipes and the starboard wall, a situation that resulted in the deaths of Stevedore A and Stevedore B and serious injuries to Lashing Worker A.

4 PROBABLE CAUSES

It is probable that the accident occurred when, as Vessel A was being loaded with cargo starboard-side alongside at the Wharf, the Pipes, which had been hoisted and then stopped by the No. 1 crane, swung to the starboard side, and as a result Stevedore A, Stevedore B, and Lashing Worker A, who had been standing by and doing other activities on top of the Two Bundles, were caught between the Pipes and starboard wall.

It is probable that the Pipes, which had been hoisted and then stopped by the No. 1 crane, swung to the starboard side because—under conditions whereby, at the time of the accident, the underside of the Hull Fender on Vessel A's starboard midship hull was caught on the tops of the Wharf's fenders and Vessel A's starboard inclination was arrested because, among other reasons, the height of tide had fallen compared to that at the time of docking and the Vessel A's draft had increased—the underside of the Hull Fender came off the tops of the wharf's fenders when the Pipes were hoisted by the No. 1 crane and then stopped at the Stop Position, which caused Vessel A's hull to roll and she inclined to the starboard side.

It is probable that workers were standing by and doing other activities on top of the Two Bundles at the time of the accident because, in addition to not being prohibited from standing on top of the Two Bundles for reasons that included over the Two Bundles not being in the handling area of the Pipes, they could not predict that the Pipes would swing over the Two Bundles from the Stop Position, as theretofore Hoisted Cargo had not swing greatly when the crane operation was stopped.

5 SAFETY ACTIONS

It is probable that the accident occurred when, as Vessel A was being loaded with cargo starboard-side alongside at the Wharf under conditions whereby the underside of the starboard Hull Fender was caught on the tops of the Wharf's fenders and Vessel A's starboard inclination was thus arrested, stevedores, etc., were caught between the pipes and a wall when pipes that had been hoisted and then stopped by a crane swung when the underside of the Hull Fender came off the tops of the wharf fenders, causing the hull to roll and Vessel A to incline to the starboard side.

Accordingly, Company A, Company B, and Company C must implement the following measures to prevent occurrence of a similar accident.

- (1) When conducting cargo-handling using a deck crane on a vessel with fenders installed on the hull sides, appropriately monitor catching between the vessel's fenders and wharf fenders and build a system that allows workers inside the cargo holds to ascertain whether catching has occurred. At such times, pay attention not only to catching of the underside of the hull fender with the tops of wharf fenders but also catching of the tops of the hull fender with the underside of wharf fenders.
- (2) Demand that crew members of vessels with fenders installed on the hull sides cooperate in preventing hull rolling caused by the catching of hull fenders and wharf fenders by, for example, holding meetings prior to the start of cargo-handling and adjusting draft to the tide so that catching does not occur.
- (3) Depending on the vessel structure, type of cargo, etc., study work procedures that include refuge places and methods that anticipate hull-rolling-caused swinging of hoisted cargo and having workers enter a planned stowage position only after temporarily placing hoisted cargo on the floor and securing workers' safety, and make those procedures known to workers.
- (4) Based on the possibility that hoisted cargo may swing greatly as a result of hull rolling, etc., provide guidance to workers to ensure that they can execute their work in a manner that makes emergency responses possible; for example, by ascertaining continually changing cargo-handling conditions through constant monitoring of hoisted cargo and maintaining a posture that allows movement to previously studied refuge areas.
- (5) Periodically provide worker education that incorporates lessons learned from this accident.

5.1 Safety Actions Taken

Company A, Company B, and Company C made the general circumstances of this accident known to all of their employees and decided to implement the following actions.

5.1.1 Safety Actions Taken by Company A and Company B

- (1) If a ship will be entering port, confirm the existence of hull fenders prior to entry into port; if a fender has been installed, temporarily place large air-inflated fenders to keep it from catching on existing wharf fenders. (See Photo 5.1)
- (2) When conducting cargo-handling on a ship falling under (1) above, station observers with transceivers on the wharf and communicate the circumstances of hull fenders and

wharf fenders to stevedores in cargo holds, and request the cooperation of crew members in observing said circumstances.

- (3) Establish work plans that assume the possibility of sudden hull rolling, establish refuge places for workers to use in an emergency, and make said plans and places known to workers.
- (4) Reduce risk by implementing a risk assessment for each vessel.



Photo 5.1 Large Air-Inflated Fenders

5.1.2 Safety Actions Taken by Company C

- (1) Confirm refuge places for use in an emergency, and do not engage in work near hoisted cargo until the cargo has been landed.
- (2) Reduce risk by implementing risk assessments.

5.2 Safety Actions Required

Company A, Company B, and Company C must endeavor to prevent similar accidents by periodically providing worker education that incorporates lessons learned from this accident.

Attached Figure 1 Outline Map of the Location of the Accident Events

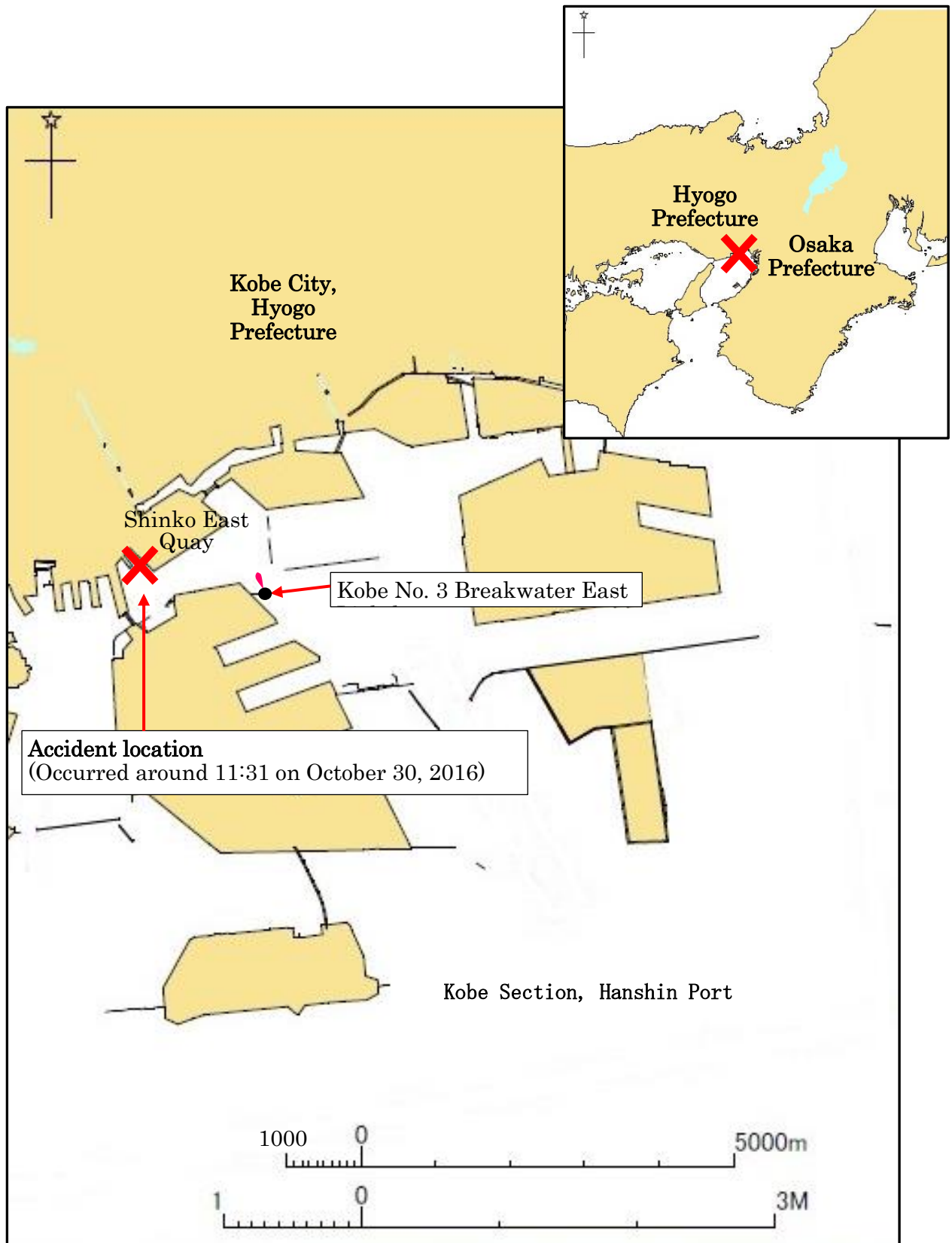

**Analytical Investigation of Hull
Inclination
(Accident involving Workers
Fatalities on Cargo Ship A)
Report**

March 2016

National Maritime Research Institute

National Institute of Maritime, Port and Aviation Technology

Table of Contents

1. Purpose of the Analytical Investigation.....	1
2. Content of the Analytical Investigation.....	1
3. Assumptions the Analytical Investigation.....	1
4. Results of the Analytical Investigation.....	2
(1) Hull inclination angle when, <u>in a case in which the fenders are not caught</u> , the cargo is suspended by the No. 1 crane at the Established Position	2
(2) Maximum hull inclination angle generated when, <u>in a case in which the fenders are caught</u> , the cargo is suspended by the No. 1 crane at the Established Position and the fenders become separated.....	4
(3) Hull inclination angle at the time of the accident from verbal statements.....	9
(4) Hull inclination angle for collision of the hoisted cargo with the starboard wall of the No. 2 cargo hold	10
5. Conclusion.....	12
Reference.....	12

1. Purpose of the Analytical Investigation

We conduct the following analyses for the purpose of studying an accident that resulted in the death or injury of workers that occurred in a cargo hold of Cargo Ship A, which was moored (starboard-side alongside) at Shinko East Quay T Wharf, Kobe Section, Hanshin Port, on October 30, 2016.

- (1) Estimation of hull inclination angle
- (2) Estimation of the circumstances of hoisted cargo attributable to hull inclination

2. Content of the Analytical Investigation

We estimate the following items after estimating Cargo Ship A's stability at the time of the accident with correction for the influence of a deck crane's jib angle based on stability-related materials of Cargo Ship A.

- (1) Hull inclination angle when suspending the cargo (pipes) at the designated position with the deck crane
- (2) Maximum inclination angle when Cargo Ship A' hull inclines during transition from a state in which her hull inclination was arrested because the lower part of her fender was caught on the wharf's fenders (1) to a state in which the caught fenders are separated
- (3) Cargo Ship A's hull inclination angle at the time of the accident from verbal statements
- (4) Hull inclination angle when the suspended cargo of (1) collided with the starboard wall of the No. 2 cargo hold due to hull inclination

It should be noted that we received detailed data required for the analyses from the Japan Transport Safety Board.

3. Assumptions of the Analytical Investigation

The calculated values of the provided stability-related materials include the weight of all cargo loaded at the time of the accident and the circumstances of the No. 1 crane's jib (angle of elevation: approx. 60°). Values for cargo, etc., do not refer to a suspended state. Additionally, we conducted the analyses based on the assumption that the state in which the jib end is oriented toward the stern (the jib is parallel with the fore-and-aft line) is a jib swivel angle of 0°; that, in the initial state (state at which the calculations of the stability-related materials were conducted), the jib's swivel angle is in its stowage state of 180° (the jib end is oriented toward the bow); and that there is no inclination of the hull.

It should be noted that the suspended position of the cargo prior to the accident that is identified in the investigation (hereinafter referred to as the "Established Position") is 2.75 meters from the floor of the No. 2 cargo hold to the bottom surface of the cargo; 4.40 meters from the starboard wall of the cargo hold to the center of the cargo and 3.00 meters to the starboard side of the cargo; and 14.90 meters from the forward bulkhead of the cargo hold to the forward side of the cargo (see Figure 1).

4. Results of the Analytical Investigation

(For the sake of analysis, numerical values are rounded off at the third decimal place.)

(1) Hull inclination angle when, in a case in which the fenders are not caught, the cargo is suspended by the No. 1 crane at the Established Position (θ_1'')

The inclination angle when the fenders are not caught can be obtained as the inclination angle when an onboard heavy load is suspended. Here, we obtain the inclination angle arising from the influence of the movement of the suspended cargo (hoisted cargo) and of the crane jib's center of gravity to examine the influence of each.

Table 1 presents the principal particulars of the ship and the ship's draught, etc., at the time of the accident. The G_0 appearing in the table is the apparent position of the center of gravity that is based on consideration of the influence of free water.

Table 1 Principal Particulars of the Ship and Draught, etc., at the Time of the Accident

L(m)	113.50
B(m)	20.20
DESIGN DRAUGHT(m)	7.00
df(m)	5.24
dm(m)	5.61
da(m)	5.99
trim by stern(m)	0.75
displacement(t)	8703.20
G_0M (m)	1.41
KG_0 (m)	7.10

According to Reference [1], the inclination angle when an onboard heavy load $w(t)$ is suspended (θ_1) is given by the following formula with the heavy load beginning at the position of the center of gravity (on the hull's center line).

$$\tan \theta_1 = \frac{wb}{GM \cdot W - wh} \quad (1)$$

Here, w is the total weight of the hoisted cargo (tons);

b is the horizontal distance from the hull's center to the belt sling's base (meters);

h is the vertical distance from the hull's center of gravity to the belt sling's base (meters); and

GM is metacentric height prior to suspension (meters)

Additionally, the GM used here represents the G_0M of Table 1; however, we shall refer to it as GM hereinafter.

Now we obtain the jib angle of elevation φ and swivel angle ψ (from the aft direction) using values found in materials provided by the Japan Transport Safety Board (hereinafter referred to as the "Materials"). The length of the jib is 37.185 (meters). At the time of the accident, a small hook (weight: 1.03 tons) was being used at the end of the jib. Therefore, the

positional relationship between the hoisted cargo in the No. 2 cargo hold and the No. 1 crane becomes that shown in Figure 1.

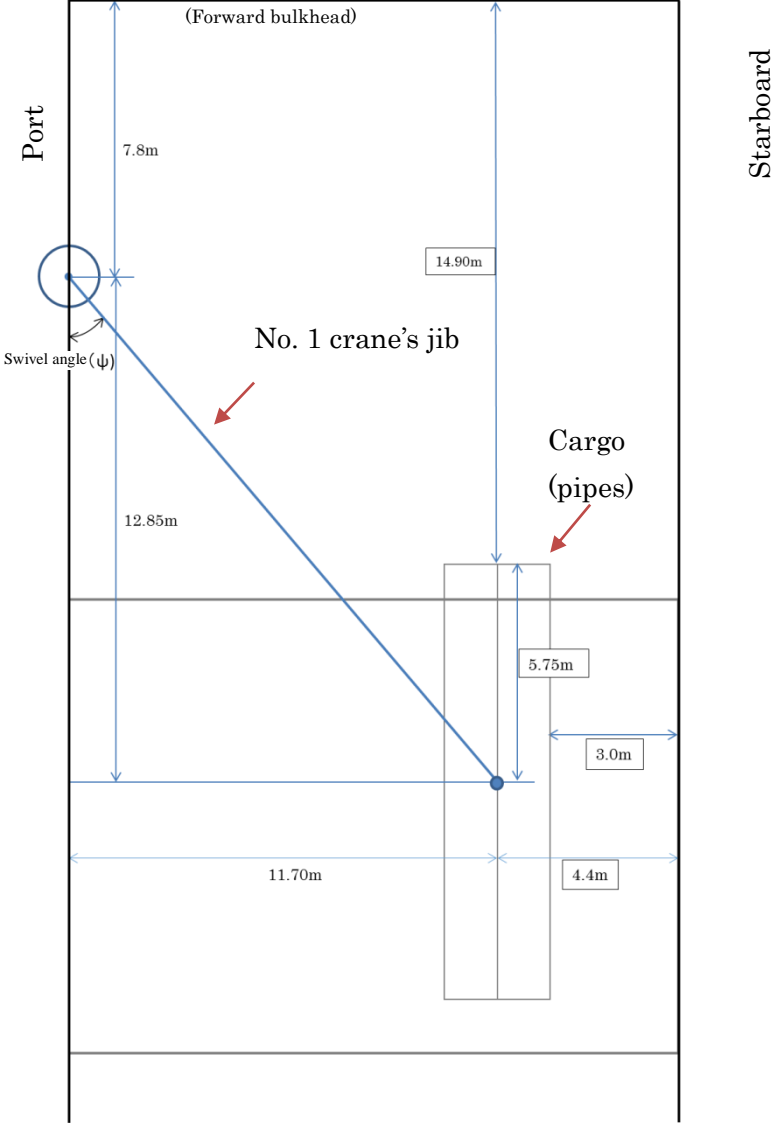

Figure 1: Positional Relationship (1) between the Hoisted Cargo and No. 1 Crane (No. 2 Cargo Hold Plan)

From Figure 1,

$$l \cos \varphi = \sqrt{11.70^2 + 12.85^2} = 17.38 \text{ (m)}$$

$$l \cos \varphi \sin \psi = 11.70 \text{ (m)}$$

From this,

$$\varphi = 62.14 \text{ (deg)}$$

$$\psi = 42.32 \text{ (deg)}$$

The total weight of the heavy load (cargo, hoisting attachments, and small hook) is

$$w = 17.93 + 1.08 + 1.03 = 20.04 \text{ (t)}$$

From Figure 1, Figure 7, and the obtained jib angle of elevation, the movement distance of the heavy load (b, h) is

$$b = B/2 - 2.05 - 4.40 = 3.65(\text{m})$$

$$h = 20.25 + 32.87 \cdot KG = 46.02(\text{m})$$

Ignoring the influence generated by movement of the jib's center of gravity at this time, from formula (1), the inclination angle (θ_1) becomes

$$\tan \theta_1 = 0.0064$$

$$\theta_1 = 0.37(\text{deg})$$

Next, we obtain the influence generated by movement of the jib's center of gravity.

If we include the weight of the large hook (weight: 6.30 tons) here, the jib's weight is

$$w' = 56.20 + 6.30 = 62.50(\text{t})$$

Assuming that the center of gravity is at the one-half point of the arm's length, the center of gravity's movement from the jib's initial state is

$$b' = l/2 \times \cos \varphi \sin \psi = 5.85(\text{m})$$

$$h' = l/2 \times (\sin \varphi - \sin 60^\circ) = 0.34(\text{m})$$

From formula (2), we find that the inclination angle caused by movement of the jib's center of gravity at this time (θ'_1) is

$$\tan \theta'_1 = \frac{w'b'}{GM \cdot W - w'h'} \quad (2)$$

$$\theta'_1 = 1.71(\text{deg})$$

Consequently, in the case in which the fenders are not caught, the angle of inclination to the starboard side when the cargo is suspended by the No. 1 crane at the Established Position becomes $\theta''_1 = \theta_1 + \theta'_1 = 2.08(\text{deg})$.

(2) Maximum hull inclination angle generated when, in a case in which the fenders are caught, the cargo is suspended by the No. 1 crane at the Established Position and the fenders become separated (θ_3)

From the Materials, the positional relationship between the hull and the wharf becomes that shown in Figure 2.

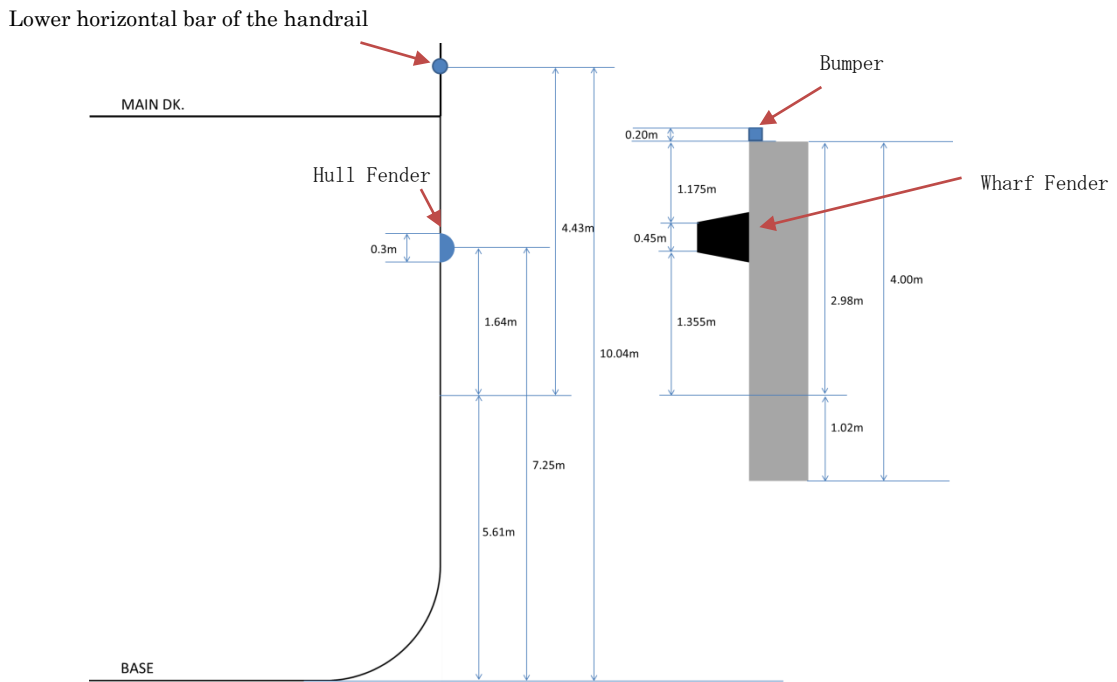

Figure 2 Positional Relationship between the Hull and the Wharf

(i) Hull inclination angle when the fenders are caught (θ_2)

The hull inclination angle when the fenders are caught (θ_2) can be obtained geometrically. Specifically, the hull inclination angle becomes θ_2 when the lower part of Cargo Ship A's fender is on top of the wharf's fender.

As is shown in Figure 3, from the Materials, the rise of the hull's fender (change in position from the state in which the fenders are not caught) is 0.315 (meters). Accordingly, if the beam is expressed as B, θ_2 as a small angle is

$$\tan \theta_2 = 0.315 / (B/2) = 0.0312$$

$$\theta_2 = 1.79(\text{deg})$$

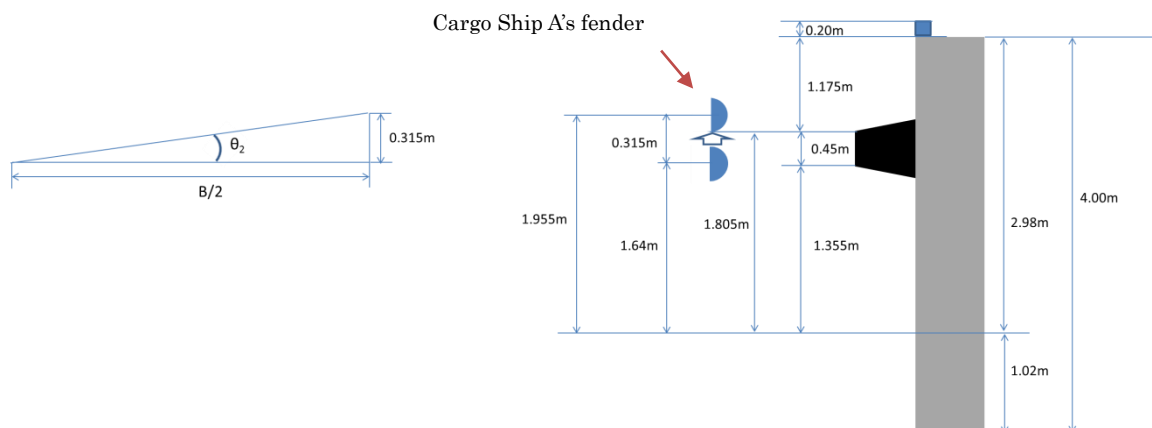

Figure 3 Upward Change in Position of the Hull Fender

(ii) Hull inclination angle when, in a case in which the fenders are caught, the cargo is suspended at the Established Position (θ''_{1a})

When the hull inclined 1.79 degrees to the port side, the end of the No. 1 crane's jib must move to the starboard side by the 1.79 degrees obtained in (i) so that the hoisted cargo will be at the Established Position (Figure 4, Figure 7). Accordingly, we again obtain the jib's angle of elevation and swivel angle and, further, obtain the inclination angle when the cargo is suspended at the Established Position with the jib at this position.

From the Materials, the height from the top surface of the hoisted cargo to the end of the jib becomes 48.35 meters (=32.87+15.48 [meters]) (Figure 7). However, because the jib has a fixed length, the jib's end cannot be moved parallel to the cargo hold's floor within the hull's cross-section. This is because when making the swivel angle larger in order to move the jib in a lateral direction, the end of the jib also moves toward the bow. To correct this, the jib's end must be moved toward the stern by making the angle of elevation smaller.

Consequently, it is necessary to move the jib's end 1.49 meters laterally when looking from above as shown in Figure 4 and, simultaneously, to move it 0.58 meters downward so that it intersects with the 1.79-degree inclination angle line, as shown in Figure 7.

Because the jib length is $l = 37.185(m)$, the jib's angle of elevation φ and swivel angle ψ at this time are

$$l \cos \varphi = \sqrt{(11.70 + 1.49)^2 + 12.85^2} = 18.41(m)$$

$$\varphi = \cos^{-1}(18.41/l) = 60.32(\text{deg})$$

$$\psi = \cos^{-1}(12.85/18.41) = 45.75(\text{deg})$$

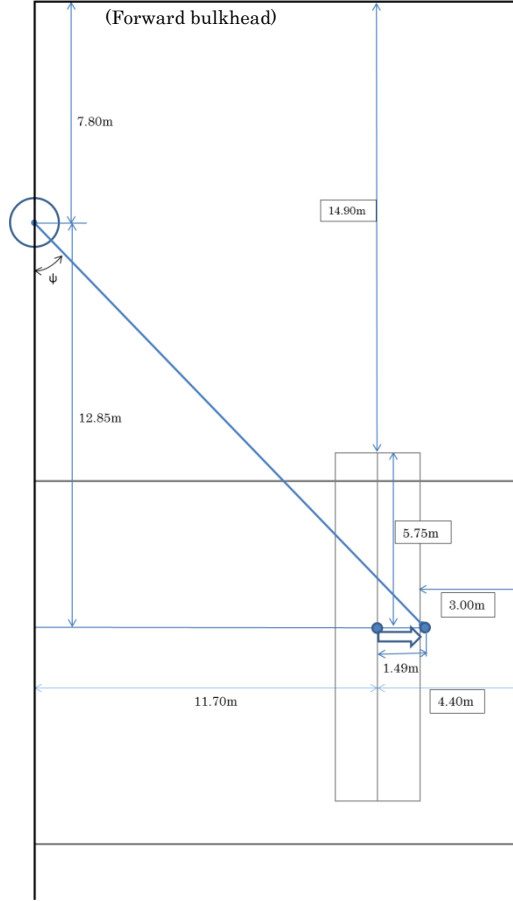

Figure 4: Positional Relationship (2) between the Hoisted Cargo and No. 1 Crane (No. 2 Cargo Hold Plan)

Next, we obtain the inclination angle when the jib's end is in the position shown in Figure 4 and the fenders are not caught (i.e., there is no initial inclination of the hull). From Formula (2), the inclination angle caused by the jib is

$$b' = l / 2 \times \cos \varphi \sin \psi = 6.60(m)$$

$$h' = l / 2 \times (\sin \varphi - \sin 60^\circ) = 0.051(m)$$

$$\theta'_{1a} = 1.92(\text{deg})$$

Consequently, adding the inclination angle of 0.52 (degrees) caused by the hoisted cargo that we obtained using the same method used in (1), starboard-side inclination angle θ''_{1a} becomes

$$\theta''_{1a} = 2.44(\text{deg})$$

Accordingly, it is probable that, if the fenders are not caught, the ship will roll centered on this inclination angle.

It should be noted that, according to Reference [1], righting arm G_0Z' when the ship is floating at a constant inclination of just θ''_{1a} is

$$G_0Z' = GZ - GG'_0 \sin \theta - GG'_b \cos \theta \quad (3)$$

Here, GG'_b is the movement of the ship's center of gravity caused by the heavy load (cargo, hoisting attachments, and small hook) and jib (including the large hook).

$$GG'_b = \frac{(wb + w'b')}{W} \quad (4)$$

Additionally, GG'_0 is the up-and-down movement of the ship's center of gravity. In other words, it is the up-and-down movement of the hull's center of gravity caused by the suspension of the heavy load and change from the jib's 60° angle of elevation. It is expressed in the following formula.

$$GG'_0 = \frac{(wh + w'h')}{W} \quad (5)$$

(iii) Maximum hull inclination angle generated when the fenders become separated (θ_3)

Now we obtain inclination angle θ_3 based on the assumption that the workload formed by stability equalizes when the hull floating at a constant inclination of θ''_{1a} only temporary inclines θ_2 to port and then inclines up to the maximum θ_3 to starboard.

$$A_p = \int_{\theta_2}^{\theta''_{1a}} G_0 Z' d\theta \quad (6)$$

$$A_s = \int_{\theta''_{1a}}^{\theta_3} G_0 Z' d\theta \quad (7)$$

$$A_s = |A_p| \quad (8)$$

Here,

A_p is the work formed by the stability when the hull inclines θ_2 to port and then inclines up to θ''_{1a} to starboard.

A_s is the work formed by the stability when the hull inclines up to θ''_{1a} to starboard and then inclines up to θ_3 to starboard.

Now, considering the inclination angle to starboard as true results in

$$\theta''_{1a} = 2.44(\text{deg})$$

$$\theta_2 = -1.79(\text{deg})$$

$G_0 Z'$, which we obtained by correcting the righting arm provided in the stability-related materials with Formula (3), and its approximation formula are shown in Figure 5.

Maximum hull inclination angle θ_3 generated when the fenders become separated is obtained by Formulas (6) to (8) using $G_0 Z'$ of this approximation formula and inclination

angles θ_{1a}'' and θ_2 as

$$\theta_3 = 6.93(\text{deg})$$

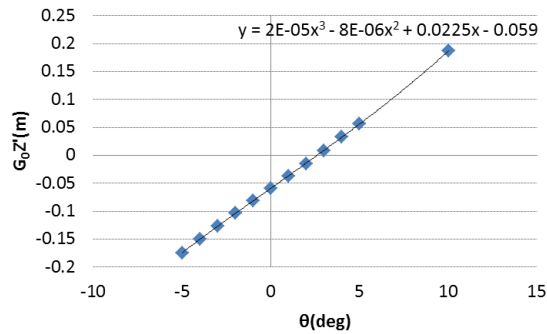

Figure 5 Righting Arm G_0Z' and its Approximation Formula

(3) Hull inclination angle at the time of the accident from verbal statements (θ_3')

According to verbal statements, at the time of the accident, Cargo Ship A's hull inclined to the point that the lower horizontal bar of a handrail was at the same height as a bumper on the wharf. We obtain this as inclination angle θ_3' .

The height from the ship's bottom to the relevant position of the handrail is provided in the Materials, and the difference between this height and the top of the bumper on the wharf is 1.25 meters (Figure 6). Accordingly, if the beam is expressed as B, θ_3' as a small angle is

$$\tan \theta_3' = 1.25 / (B/2) = 0.124$$

$$\theta_3' = 7.06(\text{deg})$$

This value roughly matches with maximum inclination angle θ_3 generated when the fenders become separated that was obtained in (2).

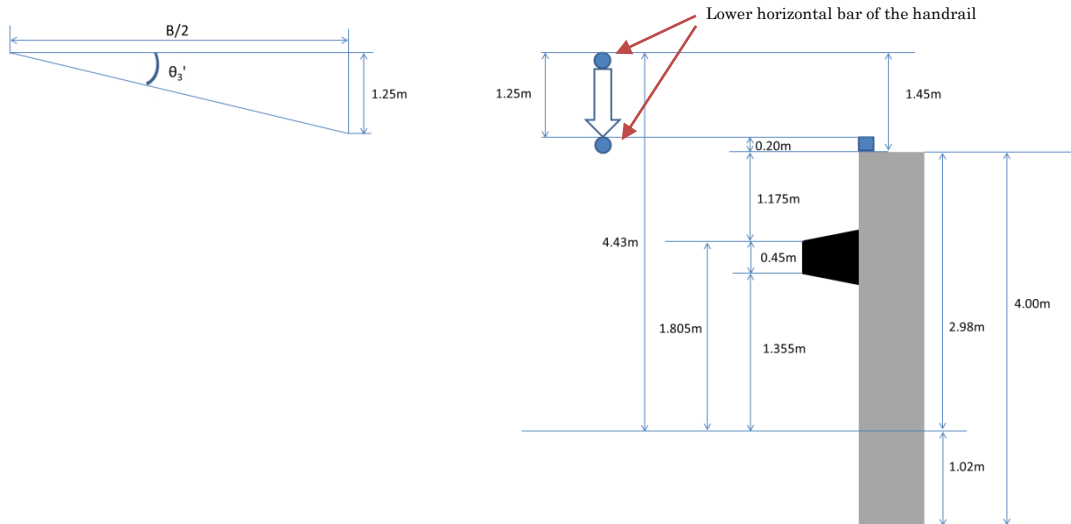

Figure 6 Downward Movement of the Handrail

(4) Hull inclination angle for collision of the hoisted cargo with the starboard wall of the No. 2 cargo hold (θ_4)

We handle the hull inclination angle for collision of the cargo suspended at the Established Position with the starboard wall of the No. 2 cargo hold as being equivalent to the angle of inclination of the belt sling when the hoisted cargo collides with the starboard wall. We obtain the angle of inclination of the belt sling based on the assumption that the movement of the hoisted cargo with the hull's inclination will be the same as a pendular traveling path centered on the position of the jib' end that we obtained in (2). Moreover, we assume that the hoisted cargo will travel in a left-right direction at this time.

$$\theta_4 = \sin^{-1}(s_w / l_w) = 1.81(\text{deg})$$

Accordingly, the hull inclination angle for collision of the hoisted cargo with the starboard wall of the No. 2 cargo hold becomes 1.81 degrees.

It should be noted with regard to the height of the bottom surface of the hoisted cargo from the cargo hold's floor at this time (h_c), because the height of the bottom surface of the hoisted cargo from the cargo hold's floor when there is no hull inclination (h_l) is

$$h_l = 2.75 - l_w(1 - \cos \theta_2) = 2.73(m)$$

height h_c becomes

$$h_c = h_l + l_w(1 - \cos \theta_4) = 2.75(m)$$

In other words, hoisted cargo at a height of 2.75 meters from the cargo hold's floor when the hull is inclining 1.79 degrees to port collides with the starboard wall at a height of 2.75 meters from the cargo hold's floor.

5. Conclusion

To contribute to the investigation of the accident that resulted in the death or injury of workers on Cargo Ship A, we estimated the hull inclination angle at the time of the accident and estimated the circumstances of the hoisted cargo resulting from the hull inclination. As a result, it is probable that the circumstances of Cargo Ship A's hull inclination at the time of the accident can be explained by the occurrence of a hull roll when, under conditions in which the lower part of Cargo Ship A's fender was caught on the tops of wharf fenders and the ship's starboard inclination was therefore arrested, the fenders became separated when the cargo was suspended at the Established Position by the deck crane. Additionally, it is probable that, if the hull inclined to starboard by 1.81 degrees or more, cargo suspended at the Established Position would be in a state whereby it would collide with the starboard wall of the No. 2 cargo hold.

Reference

- [1] Morita, Tomoharu, *Senpaku Fukugen-ron: Kiso to Oyo* (theory of ship stability: fundamentals and application) (Kaibundo), pp. 97-100, 3.2 *Jiyusui ni yoru fukugen-ryoku no gensho* (f) *Jiyusui ni nita seishitsu wo motsu kamotsu* (reduced stability caused by free water (f) cargo with qualities that resemble free water)